

# Data Sheet



Article number: 12621000050000

Description: Industrial tool 621 000 050.000  
For M5

## Measures

---

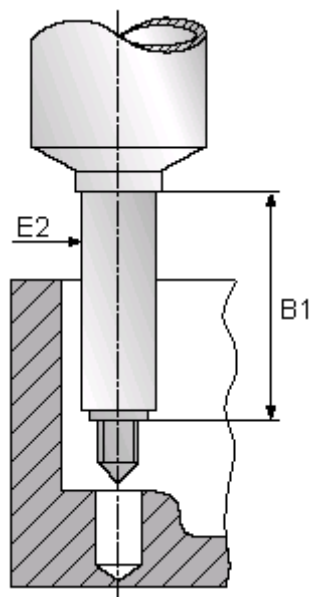

B1 = 50

E2 = 9

For thread = M5